



CU-Structural Soil® installation at Zuccotti Park, New York City

CU-Structural Soil®

A Comprehensive Guide



Founded in 1980 with the explicit mission of improving the quality of urban life by enhancing the functions of plants within the urban ecosystem, the Urban Horticulture Institute program integrates plant stress physiology, horticultural science, plant ecology and soil science and applies them to three broad areas of inquiry.

They are:

- The selection, evaluation and propagation of superior plants with improved tolerance of biotic and abiotic stresses, and enhanced functional uses in the disturbed landscape.
- Developing improved technologies for assessing and ameliorating site limitations to improve plant growth and development.
- Developing improved transplant technologies to insure the successful establishment of plants in the urban environment.

Compiled and edited by Bryan R. Denig

Authors:

Nina Bassuk, Urban Horticulture Institute,
Horticulture Section, School of Integrative
Plant Science, Cornell University
Bryan R. Denig, Urban Horticulture Institute,
Horticulture Section, School of Integrative
Plant Science, Cornell University
Ted Haffner, Urban Horticulture Institute,
Horticulture Section, School of Integrative
Plant Science, Cornell University
Jason Grabosky, Department of Ecology, Evolution,
& Natural Resources, Rutgers University
Peter Trowbridge, Department of Landscape
Architecture, Cornell University

Photo Credits:

Urban Horticulture Institute, Cornell University
Amereq, Inc.

Layout & Graphics: Bryan R. Denig

Contact: nlb2@cornell.edu

Copyright © 2015

CU-Soil® is a proprietary material patented by Cornell University and marketed under the trademarked names CU-Structural Soil® or CU-Soil®. By obtaining this material from an Amereq-licensed company, it assures that the material has been produced and tested to meet research-based specifications. To find a licensed producer in your region contact Brian Kalter (bkalter@amereq.com) or Fernando Erazo (fe@amereq.com) at Amereq Inc., 19 Squadron Blvd. New City, New York 10956. (800) 832-8788

For more information on CU-Structural Soil®, see:

<http://www.hort.cornell.edu/uhi/outreach/index.htm#soil>

<http://www.structuralsoil.com/>

Contents

PART I: An Introduction to CU-Structural Soil®

The Importance of Soil	5
Can smart species selection mitigate challenges of the urban landscape?	5
The role of soil volume on tree growth	6
What happens when roots encounter dense, compacted soil?	7
How much soil volume does a tree need?	9
Where can one find enough soil?	10
The Case for CU-Structural Soil®	11
What is CU-Structural Soil®?	11
How does it work?	12
Why is it Licensed?	13
Practical Matters and FAQ	14
What volume of CU-Soil® is needed?	14
What depth is needed for CU-Structural Soil®?	15
What is the recommended length and width for installations?	15
How does CU-Soil® perform over time?	15
How does CU-Soil® prevent heaving?	15
Can you add conventional soil in the tree pit and CU-Soil® under the pavement?	15
How do you plant trees in CU-Soil®?	15
What about irrigation and drainage?	16
Can CU-Soil® be used in urban areas without pavement over the root zone?	16
Can CU-Structural Soil® be retrofitted for use under existing trees?	16
CU-Structural Soil® quality control and installation	16
What are the oldest installations of CU-Soil®?	16
Obtaining CU-Structural Soil®	17

PART II: How to Use CU-Structural Soil®

Growing Trees in CU-Soil®	19
New Streetscape Tree Plantings	20
Trees in Plazas and Parking Lots	21
Growing larger trees in parking lot islands with CU-Structural Soil®	21
Freeing Existing Trees from Tree Pits Using CU-Structural Soil®	22
Creating Break-out Zones from Narrow Tree Lawns	22
Saving Existing Trees Threatened by Construction	23
Using CU-Soil® Under Porous Pavement	24
Permeable Pavers	24
Porous Asphalt	25
Designing with CU-Soil® and Porous Asphalt	25

Using CU-Structural Soil® with Turf	27
Designing and Working with Turf/CU-Soil® Systems	28
Turf/CU-Structural Soil® Systems and Stormwater	28
Benefits of Using CU-Structural Soil® to Remove Pollutants	29
Turf in Parking Lots	29
Design of a Turf-covered Fire Access Lane using CU-Soil®	30
Design Assumptions.....	31
Modifications for Design	31
Notes on Soil Types	32
 PART III: Case Studies	
Porous Parking Lot, Ithaca NY.....	35
McCarren Park, Brooklyn NY.....	38
W. State Street, Ithaca NY.....	40
Green Street, Ithaca NY.....	41
Mann Library, Ithaca NY.....	43
Car Dealership Turf Median, Birmingham, AL	45
 PART IV: Resources	
Installation Specifications.....	47
Choosing Trees Appropriate for use in CU-Structural Soil®.....	51
Standard Design Details.....	52
CU-Structural Soil® Break-out Zone from Narrow Tree Lawn to Adjacent Property	52
Typical Tree Planting Pit with CU-Structural Soil® along Sidewalk	53
Typical Tree Planting Island in a Parking Lot with CU-Structural Soil®.....	54
Further Information.....	55

PART I

An Introduction to CU-Structural Soil®

The Importance of Soil

The fact that trees have difficulties surviving in urban and suburban environments is not a surprise. Urban areas are rarely designed with trees in mind. Trees are often treated as if they were afterthoughts in an environment designed and built for cars, pedestrians, buildings, roadways, sidewalks and utilities. Studies report that trees in urban areas and especially in less residential areas live an average of 20-30 years,¹ and 19-28 years from a review of 11 cities.² These same species could live for much longer in a forest environment.



This city tree was clearly added as an afterthought

Urban trees face a range of environmental challenges, such as increased heat loads, de-icing salts, soil and air pollution, and interference from utilities, vehicles and buildings. Yet the most significant problem that urban trees face is the scarcity of soil suitable for root growth.³ While many of the

¹ Nowak, D J, Kuroda, M and Crane, D. "Tree mortality rates and tree population projections in Baltimore, Maryland, USA" *Urban Forestry and Urban Greening* 2.(2004) 139-147

² Roman, L.A. "How many trees are enough? Tree death and the urban canopy" *Scenario Journal: Scenario 04: Building the Urban Forest.*(2014)

³ Lindsey, P. and N. Bassuk. "Redesigning the urban forest from the ground below: A new approach to

problems urban trees face can be mitigated by planting species that are tolerant of a given challenge, there are no tree species that can tolerate the extreme soil compaction that is prevalent throughout urban and suburban landscapes.

Can smart species selection mitigate challenges of the urban landscape?



A large volume of uncompacted soil, with adequate drainage, aeration, and reasonable

specifying adequate soil volumes for street trees." *Arboricultural Journal* 16 (1992): 25-39.

fertility, is the key to the healthy growth of trees.^{4,5} The upfront investment in making the soil suitable for supporting a healthy tree is paid back in full when that tree fulfills the functions for which it was planted. These functions may include shade, beauty, noise reduction, wind abatement, pollution reduction, stormwater mitigation, wildlife habitat, and the creation of civic identity. An adequate soil volume is key, considering that soils are where the nutrients, water and air are held in a balance that allows for root growth and water and nutrient acquisition. Simply put, when soils are inadequate, plant growth suffers and trees die prematurely.



The standard (but entirely inadequate) city tree pit. It's not surprising that trees in these situations have shorter lifespans.

The role of soil volume on tree growth

Human activities can severely damage soil structure. The process of construction in a city, or even the installation of a sidewalk in an otherwise rural area, necessarily dictates a high level of soil disturbance. Any construction effort requires soil excavation, cut and fill, re-grading, and soil compaction. Often heavy machinery is brought on site to accomplish this work, increasing the potential for compaction of soils.



Compaction of soil in preparation for pavement



Surface evidence of severe soil compaction

There are two critical effects of soil compaction which directly impact plant growth and limit useable rooting space:

1. Soil structure is destroyed, and the majority of large interconnected pores (macropores) are

⁴ Perry, T. O. "The ecology of tree roots and the practical significance thereof." *Arboricultural Journal* 8 (1982): 197-211.

⁵ Craul, P. J. *Urban Soil in Landscape Design*. New York: John Wiley & Sons, Inc., 1992.

crushed. This results in a restriction of the soil's water drainage and subsequent aeration.

2. As the macropores are crushed, soils become denser, eventually posing a physical barrier to root penetration. There are numerous accounts of urban soils being literally as "dense as bricks".⁶



Soil that is light, porous, and suitable for growing trees



Severely compacted soil that is "dense as bricks" and not conducive to tree root growth

What happens when roots encounter dense, compacted soil?

When roots encounter dense soil, they change direction, stop growing, or adapt by remaining

⁶ Patterson, J. C., J. J. Murray, and J. R. Short. "The impact of urban soils on vegetation." Proc. 3rd METRIA Conference (1980): 33-56.

abnormally close to the surface. This superficial rooting makes urban trees more vulnerable to drought stress and can cause pavement heaving. Also, if a dense soil becomes waterlogged, the tree roots can rot from lack of oxygen.



Trees planted in severely limited soil volumes die young unless their roots are able to break past compacted soils into an adequate volume of useable soil. This often results in dangerous sidewalk heaving.



The roots of this tree have grown through the compacted soil beneath the sidewalk, into the large volume of soil beyond. Expanding tree roots have caused the sidewalk to heave.



Tree roots heaving pavement



Compacted soils can cause a "containerizing" effect on trees, making them especially vulnerable to wind throw



Thick superficial roots that have caused a sidewalk to heave.



With paving removed, it is easy to see how this tree's roots took advantage of the weak points in the pavement. While the tree survived, the expanding roots caused the pavement to fail.



Besides limiting root growth, compacted soil drains poorly. Seen here, pooling water and a drowned tree.

In urban soils that are not covered by pavement, it is possible to break-up, amend or replace compacted soils to make them more conducive to root growth. However, where soils are covered by pavement, the needs of the tree

come in direct opposition to specifications that call for a highly compacted base on which to construct pavement. All pavements must be laid on well-draining compacted bases so that the pavement will not subside, frost heave, or otherwise prematurely require replacement. Therefore, soils that must support pavement are often too dense for root growth. It is not surprising then that urban trees surrounded by pavement have the shortest life spans of trees in cities. Unfortunately, these paved areas also tend to be those that most need trees to mitigate the heat island microclimates that exist in downtown areas.

How much soil volume does a tree need?



Everything else being equal, access to soil volume can make a substantial difference on tree growth



*Even trees known to be tolerant of urban conditions such as honeylocust (*Gleditsia tricanthos*) suffer when given inadequate soil volumes.*

Urban trees are necessary to the health and livability of our cities, but how much useable soil is necessary to allow them to fulfill their design functions? Research at Cornell's Urban Horticulture Institute (UHI) has shown that a reasonable 'rule of thumb' for most of the United States, except for the desert southwest, is to **plan for two cubic feet of soil per every square foot of crown projection.**⁷ The crown projection is the area under the drip line of the tree. If the tree canopy is viewed as symmetrical, the crown projection can be calculated as the area of a circle (πr^2). For example: for a tree with a canopy diameter of 20 feet, the crown projection would be, 3.14×10^2 , or $3.14 (100) = 314$ square feet. Using the 'rule of thumb,' an estimate can be calculated that a tree with a 20 foot crown diameter needs approximately 600 cubic feet of soil to support it. Assuming a useable rooting depth of 3 feet, one way of dimensioning the space needed for this tree would be $20' \times 10' \times 3'$, or 600 cubic feet. It is clear that a typical $4' \times 5'$ tree opening in sidewalks, or a $6' \times 6'$ tree pit, is inadequate to allow the tree to mature to this size and fulfill its function in the landscape.

This 'rule of thumb' method is a very rough way to estimate the soil volume needs of a given tree. This method is based on determining what volume of water must be available in the soil for a tree to support itself, and accounts for climatic factors such as days between rainfalls when the evaporative demand is highest. This general 'rule of thumb' is misleading about how different soil types vary in their water holding capacities. For any given tree, the minimum volume of soil needed to support it will be different depending on how much sand, silt, and clay make up the soil composition.

Another issue with this method is that it is based on crown projection, which can cause some confusion when fastigate and narrow

⁷ Lindsey, P. and N. Bassuk. "Redesigning the urban forest from the ground below: A new approach to specifying adequate soil volumes for street trees." *Arboricultural Journal* 16 (1992): 25-39.

tree cultivars are involved. For example, determining how much soil volume is needed to support a fastigate English oak, which maintains a very narrow crown diameter, could cause confusion. In this case, it is best to decide on the intended mature size of the tree, and determine what the crown projection of a regular English oak of the same age would be. The diameter of the non-fastigate variety is then used as a proxy to determine the necessary soil volume using the two-to-one 'rule of thumb'. Another method is to determine how tall the fastigate tree of interest will be at maturity, and then substitute this height value in for the mature diameter when calculating the crown projection.

Yet another issue involves the presence of groundcovers, including lawn. In situations where trees are sharing their soil volume with other plants, even turfgrass, there is more competition for the water held in the soil. In such cases, it is best to try to provide additional soil volume.



The standard city tree pit – sometimes referred to in jest as a tree coffin

Where can one find enough soil?

If the soil under sidewalks and other paved areas were suitable for root growth, urban trees would potentially have access to large volumes of soil. This scenario would allow trees to grow to their mature size and perform as desired. Also, if the soil volume for each tree was connected and continuous, each tree would be able to share soil with its neighboring tree.

Looking at the forest as a model, trees may be spaced reasonably close together as long as they share a large common soil volume to support their needs.

Given the limited space availability in cities, it is highly desirable to be able to have soil that meets paving engineering requirements while simultaneously allowing for unimpeded root growth under the pavement. CU-Structural Soil® is one technology that meets these requirements.

The Case for CU-Structural Soil®

What is CU-Structural Soil®?

CU-Structural Soil®, also known as CU-Soil®, is a two-part system comprised of a rigid stone “lattice” that meets engineering requirements for a load-bearing paving base, and a quantity of uncompacted soil that supports tree root growth. The primary component of this soil system is a uniformly sized, highly angular crushed stone ranging from 3/4 to 1 1/2 inches in diameter with no fine materials. When this narrowly graded stone is compacted, the stones form an open “lattice” structure with about 40 percent porosity. Friction at the points where stones come in contact with one another allow the creation of the loadbearing structure of the CU-Structural Soil®.



Uniformly sized, highly angular crushed stone

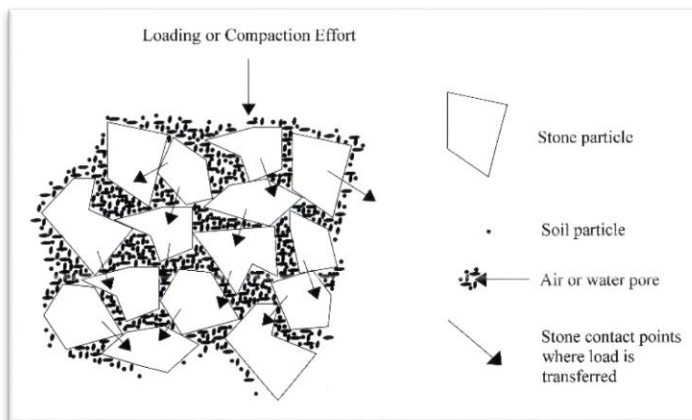

CU-Structural Soil® conceptual diagram

The second component of the system is a soil which fills the voids in the stone “lattice”. As long as care is taken to not add too much soil to the mix, which would prevent the stone structure from forming, the soil in the voids will remain non-compacted and root penetrable. Since among soil textures, clay has the most water and nutrient-holding capacity, a heavy clay loam or loam, with a minimum of 20% clay, is used in the CU-Structural Soil® system. A minimum of 20% clay is also essential for an adequate cation exchange capacity. It should also have organic matter content ranging from 2%-5% to ensure nutrient and water holding while encouraging beneficial microbial activity.

With carefully chosen uniformly-graded stone and the proper stone-to-soil ratio, a medium for healthy root growth is created that also can be compacted to meet engineers’ load-bearing specifications. The intention is to “suspend” the clay soil between the stones without over-filling the voids, which would compromise aeration and bearing capacity.

In addition to the stone and soil components, CU-Structural Soil® utilizes Gelscape® Tackifier as a non-toxic, non-phytotoxic tackifier. The structural soil process benefits from adding a tackifying agent to stabilize the mixing process. The tackifier allows for the stones and soil to mix uniformly and prevents separation of the materials resulting from vibration in transit, dumping, and working of the material in installation.



Gelscape® Tackifier being applied to uniformly sized crushed stone. Photo courtesy Amereq, Inc.



Close-up of angular stone with Gelscape® Tackifier applied (prior to admixing with clay loam soil)



Clay loam soil is mixed with the crushed stone. The added Gelscape® Tackifier helps it “stick” and prevents settling during construction. Photo courtesy J-V Environmental Services



CU-Structural Soil® being delivered to project site. Photo courtesy Minick Materials Company



Compaction of CU-Structural Soil® during installation. For proper installation, CU-Structural Soil® must be compacted every 6 inches. Photo courtesy AZ Best, LLC



Closeup of CU-Structural Soil® after installation

How does it work?

The stone components of CU-Structural Soil® come together during compaction, forming a strong, load-bearing, compacted stone base suitable for paving over, while the large voids between the stones provide room for an uncompacted clay loam soil and allow for root growth and aeration of the root zone.

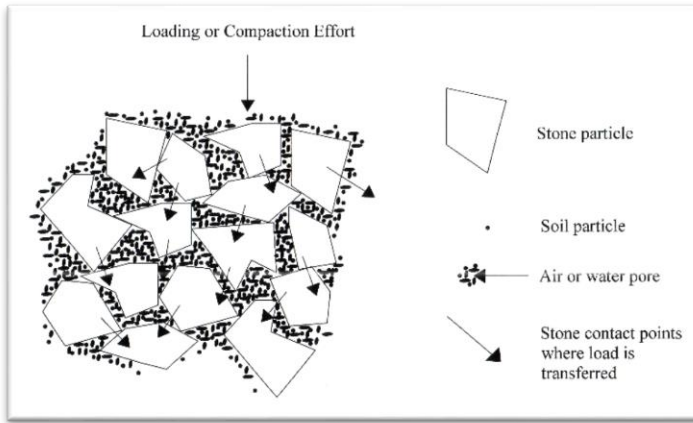

CU-Structural Soil® conceptual diagram

To be suitable as a base course that has high load-bearing ability and as a medium that supports tree growth, the ratio of stone-to-soil materials is a major consideration. If the stone voids are overly filled with soil, aeration and bearing capacity of the system are compromised. Too much soil will change the formation of the stone lattice resulting in an unacceptable decrease in bearing capacity. Not enough soil in the system limits tree growth.

Why is it Licensed?

CU-Structural Soil® has been patented and licensed to qualified producers to ensure quality control; its trademarked names are CU-Structural Soil® or CU-Soil®. By obtaining this material from an Amereq, Inc.-licensed company, it assures that the material has been produced and tested to meet research-based specifications. Many individuals have employed systems termed “structural soils”, but they are not the same as CU-Structural Soil®.



Extensive fibrous root system from a tree grown in CU-Structural Soil®



Root system of a tree grown in CU-Structural Soil® (left) compared to one grown in a regular compacted soil (right). Root systems are shown at three years post-transplant.

Practical Matters and FAQ

What volume of CU-Soil® is needed?

Similar to naturally occurring soil types, to quickly estimate the volume of CU-Structural Soil® needed to support a mature tree, it is best to **plan for two cubic feet of CU-Soil® per every square foot of tree crown projection.**⁸

Trees growing in CU-Structural Soil® in areas that normally use irrigation to grow trees should also provide low volume drip irrigation in CU-Structural Soil® installations.

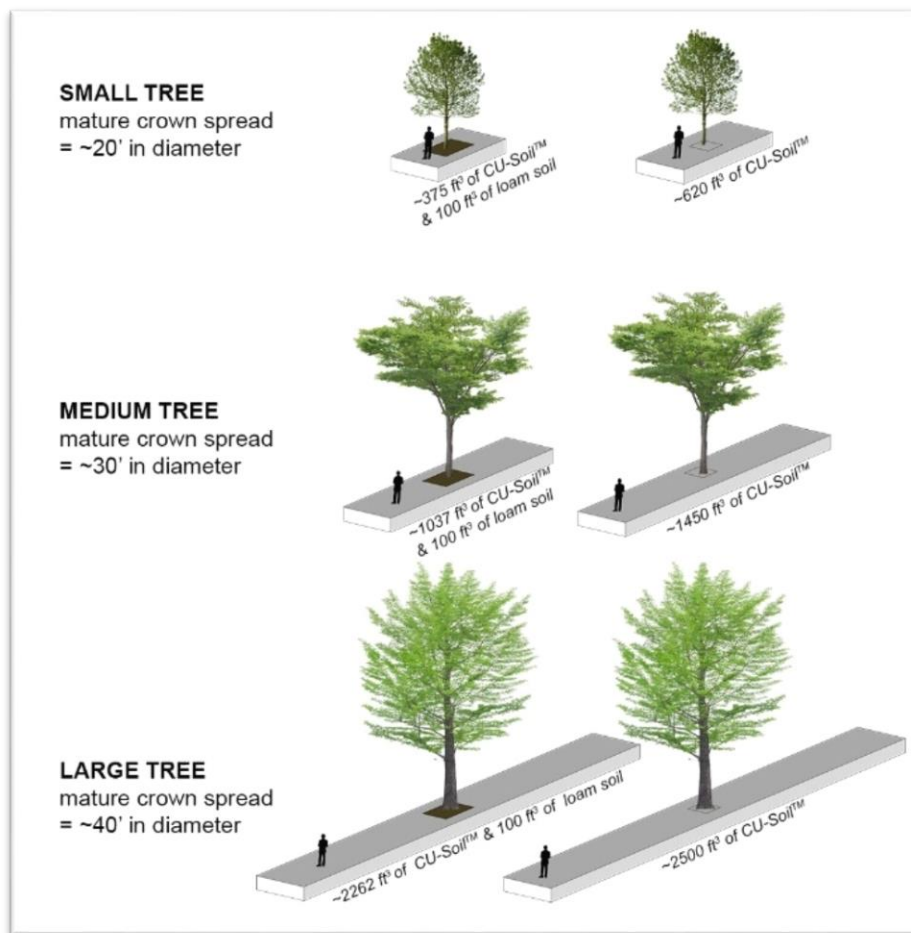

CU-Structural Soil® volumes needed to support trees of various sizes

⁸ Lindsey, P. and N. Bassuk. "Redesigning the urban forest from the ground below: A new approach to specifying adequate soil volumes for street trees." *Arboricultural Journal* 16 (1992): 25-39.

What depth is needed for CU-Structural Soil®?

For typical street tree applications, a minimum depth of 24" is required, but 36" is preferred. For turf installations used with CU-Soil®, a minimum depth of 12" is recommended (please refer to the turf portion of this guide).

What is the recommended length and width for installations?

There are no established minimums. However, CU-Structural Soil® was designed to ideally go under entire pavement areas. This homogeneity ensures uniform engineering characteristics below the pavement, particularly in regard to frost heaving and drainage.

How does CU-Soil® perform over time?

The excavation of a seven-year-old installation did not show any soil migration. The pores between stones in CU-Structural Soil® are mostly filled with soil, so there are few empty spaces for soil to migrate to.



Excavation of a tree growing in CU-Structural Soil®

Over a long period of time, the soluble salts from which the hydrogel tackifier was produced, (i.e. potassium and nitrogen from the Potassium Propenoate-Propenamide Copolymer) are released. The inert hydrogel

tackifier becomes a minimum part of the soil system. Beyond that, it appears that colonizing roots and other organisms will, over time, replace the spatial and tackifying roles of the hydrogel.

How does CU-Soil® prevent heaving?

As we have observed, the roots of trees grown in CU-Structural Soil® are deep down in the profile, spread over a larger area which helps prevent sidewalk heaving during expansion.

Additionally, there is no evidence of frost heave damage in the Ithaca, New York installations (which include some of the oldest CU-Soil® installations). Based on drainage testing and swell data on this extremely porous system, CU-Structural Soil® appears quite stable.

Can you add conventional soil in the tree pit and CU-Soil® under the pavement?

It is recommended to use CU-Structural Soil® under the tree ball to prevent the root ball from sinking. Planting trees directly in CU-Structural Soil® provides a firmer base for unit pavers close to the root ball than conventional soil. If the tree pit is sufficiently large, greater than 8' x 8', an uncompacted sandy loam soil could be used in the open tree pit surrounding the root ball with CU-Structural Soil® extending under the pavement.

How do you plant trees in CU-Soil®?

Planting a tree into structural soil is fairly simple. If possible, the pavement opening should be large enough to allow for buttress root formation on older trees. This opening could be paved in removable pavers or mulched. The tree is simply planted into the structural soil as it would be in a traditional soil. The roots will grow directly into the CU-Structural Soil®. If there is a large unpaved opening around the tree (at least 8' X 8'), it is possible to use a sandy loam soil in this opening and then CU-Soil® under the pavement. It is presumed that supplemental

watering will be provided for establishment as would be expected for any newly planted tree.

What about irrigation and drainage?

As would be expected in any soil, it is crucial to water the newly planted tree until it is established and possibly include additional, under pavement irrigation as part of a long-term maintenance plan as dictated by local conditions. In regions where irrigation is necessary to grow trees, low volume under pavement irrigation systems have been used successfully.

Provision for an irrigation system for trees planted in CU-Structural Soil® may be necessary and become part of a maintenance program. Given the large volume of structural soil for tree roots to explore, the need for sufficient irrigation must be determined by local as well as long-term maintenance needs. Taking into account the available moisture holding capacity, it is recommended to use CU-Soil® in larger volumes to provide similar moisture availability as traditional soils. In CU-Soil®, the total root system grows to occupy a more extensive area. Fertilizers can be dissolved into the irrigation water for nutritional management if necessary, although to date, nutrient deficiencies have not been observed in CU-Structural Soil® installations.

When the subgrade below the CU-Soil® is compacted and rendered essentially impermeable to moisture and roots or for any other reasons water saturation can become a problem, positive drainage below the tree root system is recommended. A perforated and wrapped drain pipe connected to the stormwater drainage system should be placed between the structural soil material and the compacted subgrade when needed to improve drainage.

Can CU-Soil® be used in urban areas without pavement over the root zone?

CU-Structural Soil® was designed to be used where soil compaction is required, such as under sidewalks, parking lots, medians, plazas, and low-access roads. Where soils are not required to be compacted, a good, well-draining soil should be used.

Can CU-Structural Soil® be retrofitted for use under existing trees?

CU-Structural Soil® has been utilized under and adjacent to existing trees. Several successful retrofits have been done in Ithaca, New York. Care should be taken to excavate roots with an air excavation tool and then to keep roots covered and moist until backfilling with CU-Structural Soil®, which should occur as soon as possible. Any excavation should be done under guidance from an arborist. Trees should be kept well-watered during the current and next growing season to compensate for any possible root damage.

CU-Structural Soil® quality control and installation

CU-Structural Soil® is produced by Amereq Inc.-licensed companies as needed and is preferably not stockpiled. All materials are tested by an independent soils lab. It is produced and delivered and should be installed in a timely manner. If any short-term stockpiling is required, protection from rain and contamination should be provided.

What are the oldest installations of CU-Soil®?

The two oldest installations date to 1994. There are now thousands of projects of various sizes across the United States, Canada and other countries. For more information about installations, visit www.structuralsoil.com or contact Brian Kalter at Amereq, Inc. (see below).

Obtaining CU-Structural Soil®

CU-Structural Soil® has been patented and licensed to qualified producers to ensure quality control; its trademarked names are CU-Structural Soil® or CU-Soil®. By obtaining this material from an Amereq-licensed company, it assures that the material has been produced and tested to meet research-based specifications. There are licensed producers throughout the US, Canada and other countries. To find the one in your region contact Brian Kalter (bkalter@amereq.com) or Fernando Erazo (fe@amereq.com) at Amereq Inc., 19 Squadron Blvd. New City, New York 10956. (800) 832-8788

PART II

How to Use CU-Structural Soil®

Growing Trees in CU-Soil®



Trees planted in a trench of CU-Structural Soil® in Campbell, CA. The photo on the right is looking up into the canopy of one of these trees. Photos courtesy TMT Enterprises, Inc.

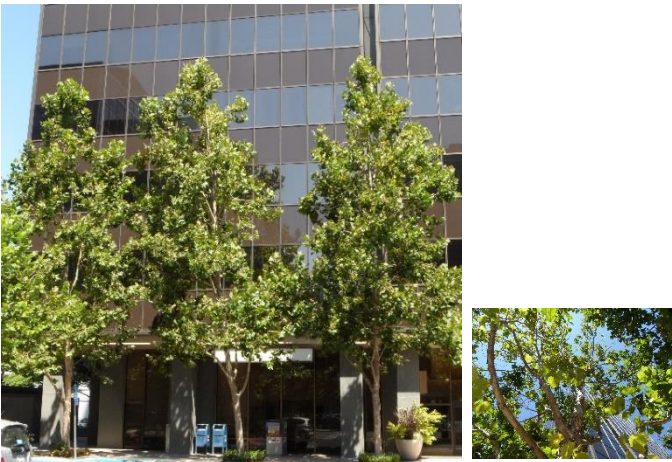

Trees planted in standard tree pits in Campbell, CA. The photo on the right is looking up into the canopy of one of these trees. Photos courtesy TMT Enterprises, Inc.

CU-Structural Soil® was designed to provide increased soil volumes for tree roots under pavements. It can and should be used under sidewalks, parking lots, pedestrian mall pavements and low-use vehicular roads. Research at Cornell University has shown that tree roots in CU-Structural Soil® grow deep into the profile, even up to 36", away from the fluctuating temperatures at the pavement surface. Because of this, the roots are less likely to heave and crack pavement systems. This has been demonstrated by both research and real-world projects over the past 15+ years.

Planting a tree into CU-Structural Soil® is much like conventional planting. If possible, the pavement opening should be expandable (via removable pavers or using a mulched area) for the sake of the anticipated buttress roots of the maturing tree. CU-Structural Soil® should be used at a depth of at least 24" but preferably 36". CU-Structural Soil® can be used right up to the surface grade where there is a pavement opening that is large enough to allow for tree installation. Depending on the size of the opening, trees may be planted directly into CU-Structural Soil®.



CU-Structural Soil® under this paved sidewalk provides these street trees with a continuous large volume of usable soil. Dallas, TX. Photo courtesy Minick Materials Company

New Streetscape Tree Plantings



This new streetscape in Phoenix, Arizona provided an opportunity to incorporate a large volume of CU-Structural Soil® beneath the pavers. Photo courtesy AZ Best, LLC

New streetscape projects offer the greatest opportunity for using CU-Structural Soil®, as “thinking about the trees” can be made a priority from the very beginning of the project. Early and substantial input from a tree specialist can get the project started on the right track. By thinking about trees from the very beginning, and not merely as an afterthought, it is easier to design and construct landscapes for tree success (see Standard Design Details in Part IV: Resources).

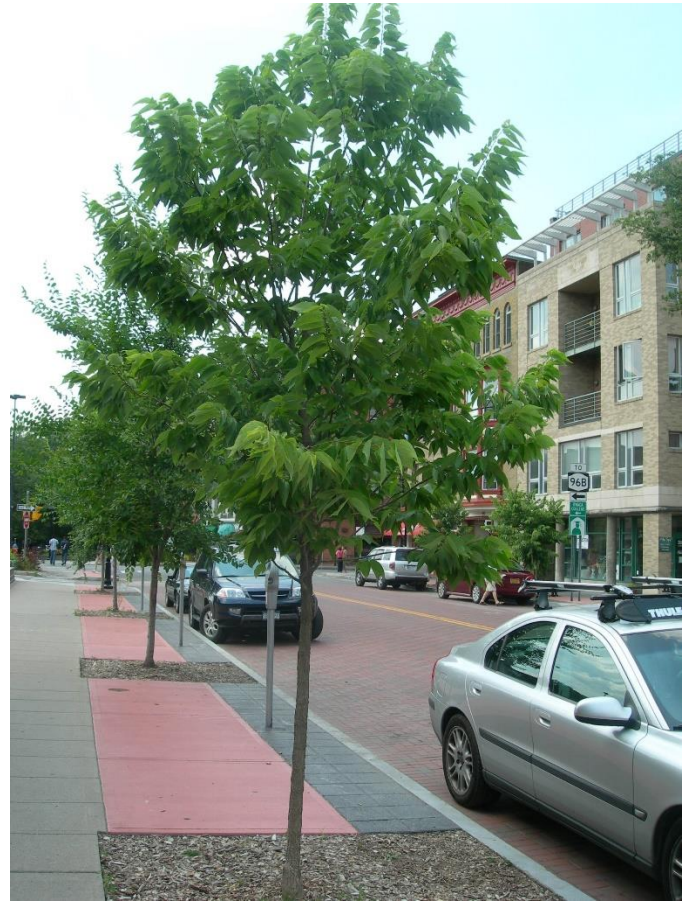

In urban situations where tree lawns are not practical, pavement over CU-Structural Soil® allows street trees to share a large-volume, continuous strip of useable soil, as seen here in Ithaca, NY.

Trees in Plazas and Parking Lots



Many urban plazas sacrifice tree useable soil volume in favor of extensive paving. By utilizing CU-Structural Soil® beneath the pavers, this plaza in Ithaca, NY has thriving trees without sacrificing paved area.

Trees in parking lots, as well as paved plazas, benefit from the use of CU-Structural Soil®. Whether there is a curb or not, good, well-drained sandy loam may be used around the tree where the opening is at least 8' x 8'. This will increase water availability to the tree roots.

If the opening is smaller, CU-Structural Soil® may be used right up to the tree ball. Although it is not necessary to use an additional base course on top of CU-Structural Soil®, some engineers may want to do so, immediately under the pavement.

CU-Structural Soil® may also be used to enlarge a 'tree island' within a parking lot. With a large tree planting area, good, well-draining sandy loam can be used in the island and CU-Structural Soil® added as an unseen rooting medium under adjacent asphalt parking bays (see Standard Design Details in Part IV: Resources).

Growing larger trees in parking lot islands with CU-Structural Soil®

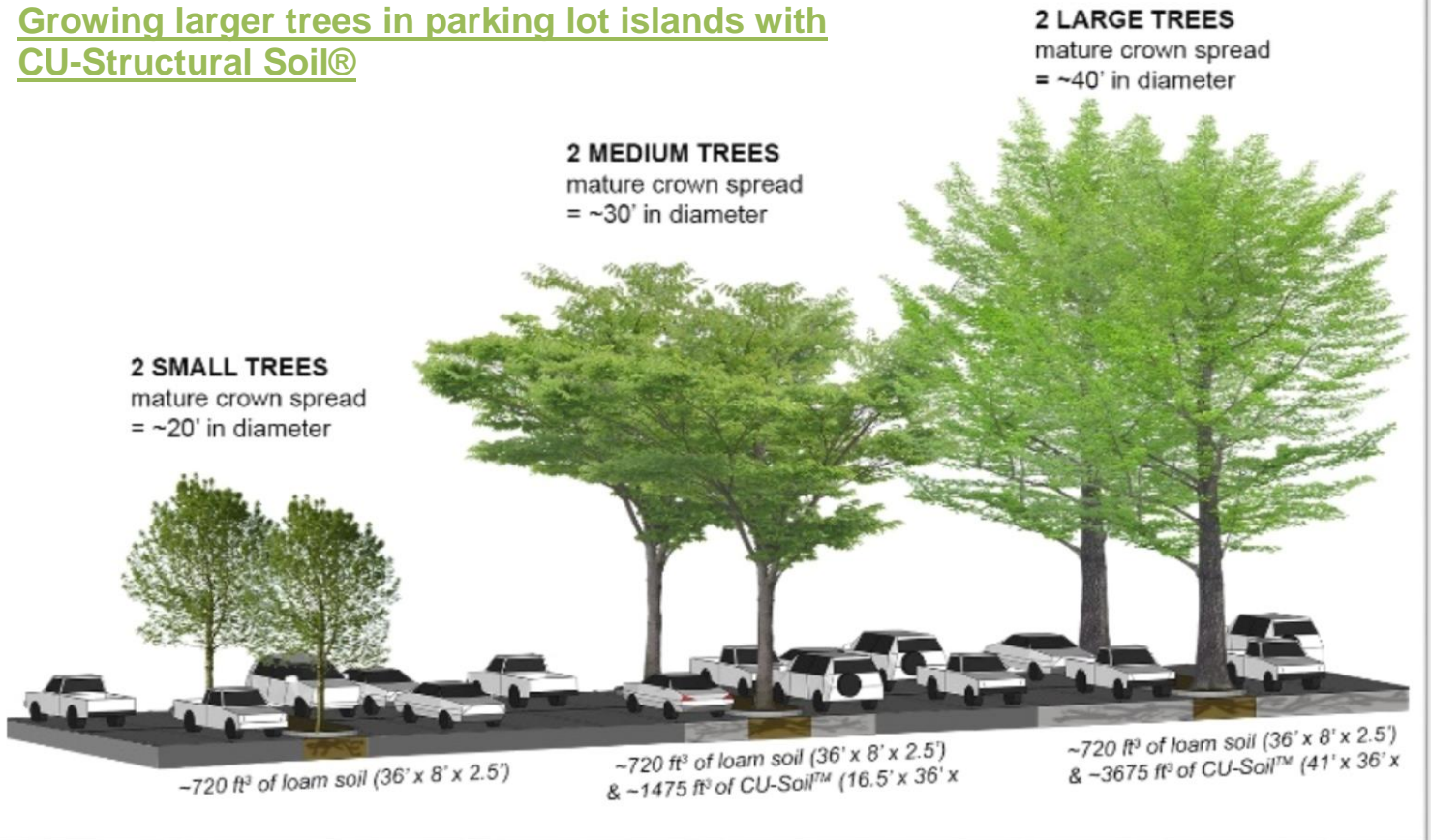

Freeing Existing Trees from Tree Pits Using CU-Structural Soil®



Renovation of this street and sidewalk in Ithaca, NY, provided an opportunity to use CU-Structural Soil® as a 36" base course for a replaced segment of sidewalk. This renovation allows the roots of this existing tree to escape its tree pit confines.

Street renovation projects, where lengthy sections of streets and sidewalks are entirely reconstructed, offer opportunities to “free” the roots of trees that were previously confined to tree pits.

When the sidewalk on an entire urban block is to be replaced, but the existing trees and tree pits are to remain as they are, there is potential to expand the useable soil volume by using CU-Structural Soil® as a base course for the new sidewalk pavement and also as a growing medium up to 36" deep. By doing so, it is possible to link the once isolated tree pits to one another by a continuous length of CU-Structural Soil®, and greatly increase the usable soil volume for each tree and prevent future sidewalk heaving.

Creating Break-out Zones from Narrow Tree Lawns



Removing this sidewalk section, and replacing it with one that has a CU- Soil® base, will allow tree roots to grow out from the tree lawn. Ithaca, NY



Because this tree lawn is so narrow, a sidewalk section has been removed, and a replacement will be poured on this CU- Soil® base. Ithaca, NY

Where there is an adjacent green space, whether a park or front lawn, CU-Structural Soil® may be used as a channel for roots to safely grow under sidewalk pavement and into the green space. Generally two concrete sidewalk flags are removed, the area is excavated to 24"- 36", and CU-Structural Soil® is backfilled into the area. Paving slabs are then replaced in a conventional manner (see Standard Design Details in Part IV: Resources).

Saving Existing Trees Threatened by Construction



The roots of this katsura tree were threatened by construction of a new plaza. The tree was saved due to careful planning, and the use of CU-Structural Soil® around the existing tree roots. Pavers were installed directly on top of CU-Soil®

Sometimes planned construction activity and paving projects can threaten the root systems of mature trees. When extensive paving is planned in the root zone of mature existing trees, it is possible to use CU-Structural Soil® as a means to save the threatened tree.

In preparation for new paving, the soil around existing tree roots can be excavated using a non-injurious method such as an air excavation tool. CU-Structural Soil® is then used as the base course for the new paving. Because the depth of the base course required for the pavement might mean that the paved area is “built up”, on top of the tree roots, rather than “dug down” (which would destroy the roots),

special design consideration must be given to the finished elevation of the final paving.

Using CU-Soil® Under Porous Pavement⁹

Stormwater concerns are receiving an increasing amount of attention from the general public, and there is currently growing interest in storing and infiltrating stormwater on site. Traditionally, solutions to this problem involved retention and detention ponds and the use of bioswales. However, these solutions require a dedicated space, which is rarely available in densely developed urban areas. Another method for storing and infiltrating stormwater on site involves using porous paving with a gravel base course that has enough void space to serve as a reservoir for captured rainwater.

Porous paving on top of CU-Structural Soil® is different than traditional porous paving installations because of the material used in the gravel reservoir underneath the pavement surface. Traditional porous pavement technology approaches the problem only from a water quantity standpoint, and usually calls for the use of uniformly sized stone in the reservoir underneath the pavement.

CU-Structural Soil® can also be used as a base for porous pavements. Such a system has two major benefits. The first is that CU-Structural Soil® is designed to be compacted, making it easy for contractors to install. Second, CU-Soil® is engineered to support healthier tree growth in the toughest of urban environments, resulting in better plant performance in and adjacent to pavements.

CU-Structural Soil® is a viable growing medium that supports tree growth under pavement, break-out zones, retrofitting and reducing construction damage. Given the high porosity, water infiltration is very rapid

⁹ Day, S.D. and S.B. Dickinson. Managing stormwater for urban sustainability using trees and structural soils. Virginia Polytechnic Institute and State University, Blacksburg, VA. (2008)

through porous pavement and structural soil. 24 inches of CU-Structural Soil® can capture 6 inches of rainfall in 24 hours. Combined with porous pavement, CU-Structural Soil® provides a reservoir for stormwater capture under pavement.

Size of Rain Event	Depth of CU-Soil® Reservoir Needed to Mitigate Rain Event
1.56"	6"
3.12"	12"
4.68"	18"
6.25"	24"
7.8"	30"
9.36"	36"

Reservoir depths and the corresponding levels of mitigated rain events based on the 26% void space within CU-Structural Soil® mix.

Permeable Pavers

If non-mortared pavers are used, a setting bed of uniformly-graded coarse sand should be used, to a depth specified by paver manufacturer specifications. To discourage rooting in this layer, a geo-textile—one that does not restrict water movement—can be used between this material and the CU-Structural Soil®.

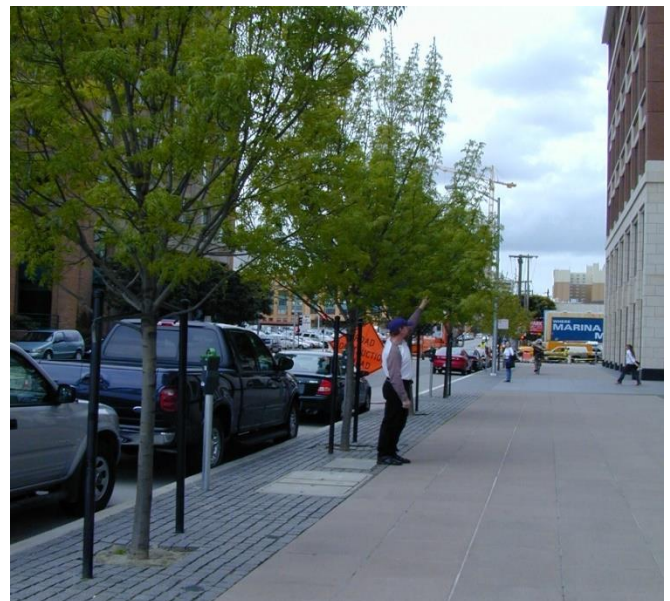

This installation uses cobble pavers with porous joints as the covering of a continuous trench of CU-Soil®.

Water is able to infiltrate the soil, while still allowing easy pedestrian access to the cars utilizing the on-street parking. San Francisco, CA.



By having porous joints between the bricks in this paving strip, water is able to infiltrate into the CU-Soil® below. Ithaca, NY.

Porous Asphalt



A porous asphalt and CU-Soil® installation in Ithaca, NY just after construction

Porous asphalt is similar to traditional asphalt in every way but the mix specification. Unlike traditional asphalt, porous asphalt leaves out the fine particles in the mix. Leaving out these

finer particles leaves gaps within the profile of the asphalt that allow water to flow through the pavement, rather than over the pavement. While porous asphalt traditionally has a crushed stone base, by substituting CU-Soil® as a stormwater reservoir it is possible to store stormwater and support tree growth.

Designing with CU-Soil® and Porous Asphalt

When using CU-Structural Soil® and porous asphalt, there are a few things that are important to keep in mind:

- Porous asphalt has its own mix specification.
- The depth of the CU-Structural Soil® reservoir underneath the porous asphalt depends on the size of the storm event that you want to mitigate.
- Infiltration rates for ground water recharge vary greatly and depend on the type of soil underneath the CU-Structural Soil® reservoir. Because of this reality, it is necessary to perform a soil test to find out the soil type and it's characteristics underneath the reservoir.
- Conventional storm drainage may be required by regulation. If this is the case, French drains or a traditional PVC drainage system may be installed below the porous asphalt surface to insure that water does not back up through the pavement profile.
- Porous asphalt needs maintenance. It should never be sealed. To keep porous asphalt porous, it should be vacuumed once every two years to remove silt and dirt particles, although this rarely occurs in practice.
- Proper sediment control measures such as silt fencing should be used during construction to keep surrounding sediment off of the porous asphalt. If not, pores in the asphalt may clog and become less effective.
- Tree planting areas should not have raised curbs. Additionally, the asphalt

should be cut for the tree pits in the later stages of construction. Trees and other landscape elements should be planted last to ensure there is no damage to them during construction.

Using CU-Structural Soil® with Turf

Primarily used as a functional groundcover in residential lawns, turf grass plantings are also found in parks, playgrounds, and athletic fields. In these situations, turf is used both architecturally for providing a sense of open green space, and functionally as a protective surface for play. With careful design and installation, lawn plantings can also be used in situations that are normally not conducive to growing turf because of soil compaction resulting from high pedestrian traffic and/or occasional vehicular traffic. Examples of these situations include farmers markets, urban park lawns used for public gatherings, limited access fire lanes, and low-use parking lots.



Turf on CU-Structural Soil® at a car dealership in Birmingham, AL. Photo courtesy Southpine, Inc.



The soil in the entire median was excavated and replaced with CU-Structural Soil®, allowing the lawn median to be used as a space to display inventory. Photo courtesy Holcombe Norton Partners



In winter when the sod is dormant, the median serves as an additional storage and display space for the inventory. Photo courtesy Southpine, Inc.

Beyond supporting trees, Cornell's UHI has conducted research of planting turf on top of CU-Structural Soil®. This is in addition to streetscape and stormwater applications to create a healthy lawn that can be used in areas that receive high levels of pedestrian and/or occasional vehicular traffic, with the added benefit of mitigating stormwater. Because CU-Structural Soil® is designed to be compacted, it will withstand heavy traffic. This allows people, cars and temporary structures to safely use a turf covered surface installed on CU-Structural Soil®, without causing soil compaction that is detrimental to the health of the turf planting.

Increased water and air within the CU-Structural Soil® medium not only allows for healthier root and shoot growth of the grass, but also allows rainwater and runoff to be collected and held within the CU-Structural Soil® reservoir in large volumes until it can slowly infiltrate into the ground below the reservoir. This reduces runoff to sewer system infrastructure and also recharges the groundwater levels. While lawns are often generalized as a porous surface, different plantings can vary greatly in their capacities to mitigate stormwater, and very compacted lawns have little ability to capture and store stormwater.



On this traditional lawn corner the turf has been worn away by automotive traffic. This traffic compacts the soil and limits drainage, essentially drowning out the grass



Here, compaction and poor drainage in a traditional lawn result in large bare spots where grass once grew.

Designing and Working with Turf/CU-Soil® Systems



Compaction of CU-Structural Soil® prior to installing sod. Photo courtesy Southpine, Inc.

Turf/CU-Structural Soil® systems require entire lawn areas to have at least 12” depth of CU-Structural Soil® just below the turf surface. This homogeneity is needed to ensure uniform engineering characteristics below the lawn, particularly in regard to frost heaving and drainage and also to support proper turf growth. For new construction projects, it is relatively easy to incorporate the required depth into the design.

CU-Structural Soil® must be compacted with a vibratory or rolling compactor in 6” lifts during installation. Once installed and fully compacted, the sod should be installed directly onto the CU-Structural Soil®, and then irrigated until well rooted and established. Once established, follow local turf maintenance programs including mowing, fertilization and irrigation.

Turf/CU-Structural Soil® Systems and Stormwater

For systems where stormwater mitigation is a goal, an additional depth of CU-Structural Soil® can be used to increase the volume of stormwater that can be stored. Because the void space for CU-Structural Soil® is approximately 26%, reservoir depths between 24” to 36” will mitigate between 6.25” and 9.36” of rain in a 24 hour period.

For example, a 24” depth of CU-Structural Soil® in Ithaca, N.Y., is capable of mitigating a 100 year storm event of 6” in 24 hours. This level of mitigation is quite high, but keep in mind that precipitation is both regional and highly variable from location to location. Also, it is important to remember that if adjacent surfaces drain towards the CU-Structural Soil® installation, the stormwater demand on the system will be increased.

A depth of 24” will both support lawn plantings and mitigate a storm event up to 6.25” in 24 hours. Less than 24” will also support lawn plantings but the reservoir will be too shallow to accommodate healthy tree root growth. For

lawns that include tree plantings, a reservoir depth of 24” to 36” is recommended.

Benefits of Using CU-Structural Soil® to Remove Pollutants

An important quality of any soil is its ability to filter pollutants from surface runoff. Suspension of runoff pollutants such as oil in the soil profile allows for the biodegradation of hydrocarbons into environmentally-harmless products by microorganisms. Through this process, runoff water is filtered before it recharges the groundwater supply.

Preliminary research by Qingfu Xiao at the University of California at Davis found that CU-Structural Soil® is effective at removing the nutrients and materials found in polluted surface runoff. Further research in this area is needed, but it is expected that colonization of CU-Structural Soil® by tree roots will further enhance the removal of runoff pollutants.¹⁰

Turf in Parking Lots

A turf covered parking lot is not a new idea, and has been used in diverse situations in the past, such as at churches and flea markets, and is now being used at professional sports arenas like Sun Life Stadium. As these examples suggest, turf is suitable for use in parking lots that receive only occasional vehicular traffic. There are a number of recommendations for designing successful turf parking lots with CU-Structural Soil®.

- Use turf in parking areas that receive occasional vehicular traffic, such as farmers markets and the overflow parking areas on the outskirts of large lots.
- To minimize vehicular wear on the turf as much as possible, place turf only in

the parking stalls and not in the driving lanes of the lot. Angled parking stalls are recommended.

- Use local stormwater data and runoff calculations to set the proper depth of the CU-Structural Soil® reservoir. Doing so will ensure the proper functioning of stormwater mitigation techniques over time.
- Soil structure underneath the reservoir will help determine infiltration and groundwater recharge rates from the reservoir into the subbase below the reservoir.
- Use additional drainage as necessary. Flooding may occur if the rate of groundwater recharge is slower than the rate that the reservoir receives both the rain and the runoff.
- Use grasses appropriate to the site conditions and specify proper post-installation maintenance. Annual fertilizer applications may be required.

¹⁰ Day, S.D. and S.B. Dickinson. Managing stormwater for urban sustainability using trees and structural soils. Virginia Polytechnic Institute and State University, Blacksburg, VA. (2008)

Design of a Turf-covered Fire Access Lane using CU-Soil®

Fire lanes are access roads or lanes that are designed to accommodate rare use by emergency vehicles, but are not intended for normal vehicular traffic. Many municipalities require buildings to be accessible to emergency vehicles, and these large and heavy vehicles require certain design accommodations. A common result of these requirements is the construction of a wide, visually obtrusive paved roadway that is rarely (if ever) used.

There is great interest in using CU-Soil® to create turf-covered fire access lanes. It is possible to use CU-Soil® to support a turf-covered fire access lane rather than a traditional design based on fatigue of the pavement section. The controlling criterion is a maximum allowable deflection (i.e. soil depression) of 0.1" due to wheel loads. Although turf has been successfully grown on CU-Soil® depths as shallow as 6", **it is recommended that at least 12" of CU-Soil® be used in turf fire lane installations** to achieve this level of stability. This depth is appropriate for most types of compacted subgrades. A few soil types require greater depths of CU-Soil® due to their inherently low resilient modulus (soil stiffness). These are detailed in the table below. All other subgrade soils require 12" of CU-Soil®. For a greater explanation of these recommendations, see Design Assumptions and Modifications for Design below.

Table. Listing of subgrade types that require more than a 12" deep layer of CU-Soil® for a fire access lane.

Unified Soil Classification System (USCS) Symbol for soil subgrade	Soil Symbol Definition	Resilient Modulus (soil stiffness) MR Default (ksi)	Minimum Thickness of CU-Soil® needed (inches)*
CH	clay of high plasticity, fat clay	4	41
MH	silt of high plasticity, elastic silt	6	27
CL	clay of low plasticity, lean clay	9	19
ML	silt	11	15

Because certain turf grasses tolerate wear better than others, for turf/CU-Soil® fire lane installations, Tall Fescue is the recommended species to use in the northern United States, while Zoysia is the recommended turf species for the southern United States. Although most fire trucks are approximately 8 feet wide, fire lanes should be designed to be at least double that width (16 feet). This width may be designed to include a heavy-duty sidewalk with a CU-Soil® base alongside the turf, or may be a turf/ CU-Soil® system by itself. Although the turf/CU-Soil® fire lane is capable of supporting a fire truck and preventing soil compaction, in certain circumstances the surface vegetation may be damaged.

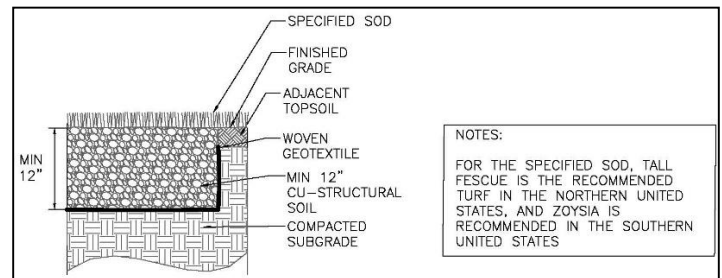

Typical section showing a turf-covered firelane using CU-Soil®

Design Assumptions

- Two layer system of CU-Soil® with turf over compacted subgrade
- The subgrade should either be undisturbed or, if reused, compacted to 95 percent Proctor density
- CU-Soil® : Minimum CBR 50 (standard for CU-Soil®)
- Subgrade soil: Varies
- Maximum 0.1 inches deflection allowed
- Fire truck dimensions

Source: *Emergency Vehicle Size and Weight Regulation Guideline* - International Fire Chiefs Association

Custom Chassis Pumper – Single Rear Axle		
	<u>Min</u>	<u>Max</u>
Front GAWR	18,000	24,000
Rear GAWR	24,000	31,000
Width (in.)	98	100
Height (ft.)	9	12
Length (ft.)	30	34

Single wheel in back (worst case) with 100 psi tire pressure. During an emergency it is feasible (and may be advisable) to lower the tire pressure on extremely soft soils.

Modifications for Design

Resilient modulus (Mr) is a fundamental material property used to characterize unbound pavement materials. It is a measure of material stiffness. The greater the Mr, the more resistant the subgrade is to deformation under a load. As shown in the table below, when the Mr is low, the required thickness of CU-Soil® is greater. When the subgrade has a high Mr, less CU-Soil® is needed.

California Bearing Ratio (CBR) is another measure of material stability. It is defined as a penetration test for evaluation of the

mechanical strength of road subgrades and base courses. It was developed by the California Department of Transportation before World War II. CU-Soil® is routinely tested for CBR and is specified as having a CBR of at least 50.

Resilient Modulus has been correlated with California Bearing Ratio for use in pavement design.¹¹ This correlation was used in the following calculations such that 50 CBR → 32,000 psi

The fire lane design assumes a saturated soil with some loss of confinement versus the CBR test so an overall strength of the CU-Soil® is assumed to be about two-thirds of the value from the correlation with CBR.

CU-Soil® Design value used: 20,000 psi

For the subgrade, the design modulus is one-half the expected (default) value due to possible poor drainage conditions in the field.

¹¹ Source: *Guide for Mechanistic-Empirical Design of New And Rehabilitated Pavement Structures - Appendix CC-1: Correlation Of CBR Values With Soil Index Properties*, National Cooperative Highway Research Program, Transportation Research Board, National Research Council, Washington, DC 2001

CU-Soil® Thickness Needed for Typical Single Axle Fire Truck Allowing 0.1" Deflection

USCS Symbol for soil subgrade	Resilient Modulus (soil stiffness) MR Default (ksi)	Thickness of CU-Soil (inches)*
CH	4	41
MH	6	27
CL	9	19
ML	11	15
SW	21	4*
SP	17	8*
SW-SC	15	10*
SW-SM	17	8*
SP-SC	15	10*
SP-SM	17	8*
SC	14	11*
SM	21	4*
GW	32	***
GP	29	***
GW-GC	24	***
GW-GM	30	***
GP-GC	23	1*
GP-GM	26	***
GC	20	5*
GM	30	***

* 12 inches is minimum for constructability, but calculated values are shown

*** Properly compacted subgrade soil can support the fire truck weight with or without the addition of the CU-Soil®

Notes on Soil Types

The Unified Soil Classification System (USCS) is one of many soil classification systems used in engineering and geology to describe the texture and grain size of a soil. The classification system can be applied to most unconsolidated materials, and is represented by a two-letter symbol. Each letter is described on the following page (with the exception of Pt):

Unified Soil Classification System (USCS)

First and/or second letters		Second letter	
Letter	Definition	Letter	Definition
G	gravel	P	poorly graded (uniform particle sizes)
S	sand	W	well-graded (diversified particle sizes)
M	silt	H	high plasticity
C	clay	L	low plasticity
O	organic		

Symbol chart

Major divisions			Group symbol	Group name	
Coarse grained soils more than 50% retained on or above No.200 (0.075 mm) sieve	gravel > 50% of coarse fraction retained on No. 4 (4.75 mm) sieve	clean gravel <5% smaller than #200 Sieve	GW	well-graded gravel, fine to coarse gravel	
			GP	poorly graded gravel	
		gravel with >12% fines	GM	silty gravel	
			GC	clayey gravel	
	sand ≥ 50% of coarse fraction passes No.4 sieve	clean sand	SW	well-graded sand, fine to coarse sand	
			SP	poorly graded sand	
		sand with >12% fines	SM	silty sand	
			SC	clayey sand	
			silt and clay liquid limit < 50	ML	silt
				CL	clay of low plasticity, lean clay
OL	organic silt, organic clay				
silt and clay liquid limit ≥ 50	inorganic	MH	silt of high plasticity, elastic silt		
		CH	clay of high plasticity, fat clay		
	organic	OH	organic clay, organic silt		
Highly organic soils			Pt	peat	

This section, “Design of a Turf-covered Fire Access Lane using CU-Soil®” created with assistance from David P. Orr, PE, PhD, Cornell Local Roads Program, Dept. of Biological and Environmental Engineering, Cornell University, Ithaca, NY 1485

Part III

Case Studies

Porous Parking Lot, Ithaca NY



Aerial view of the site

As part of a research experiment, in 2005 a 12 car parking lot was designed and constructed in partnership with the Department of Public Works for the City of Ithaca, NY. This lot was an improvement on an existing gravel parking lot adjacent to the Flood Control Channel for the city of Ithaca.

This new 150' x 18' parking lot was divided in half, with the southern half of the lot using a 3" porous asphalt surface, while the northern half used a 3" layer of medium-duty traditional impervious asphalt surface. The entire lot was excavated to a depth of 2' and CU-Structural Soil® was used as the new 2' base course for the entire lot.

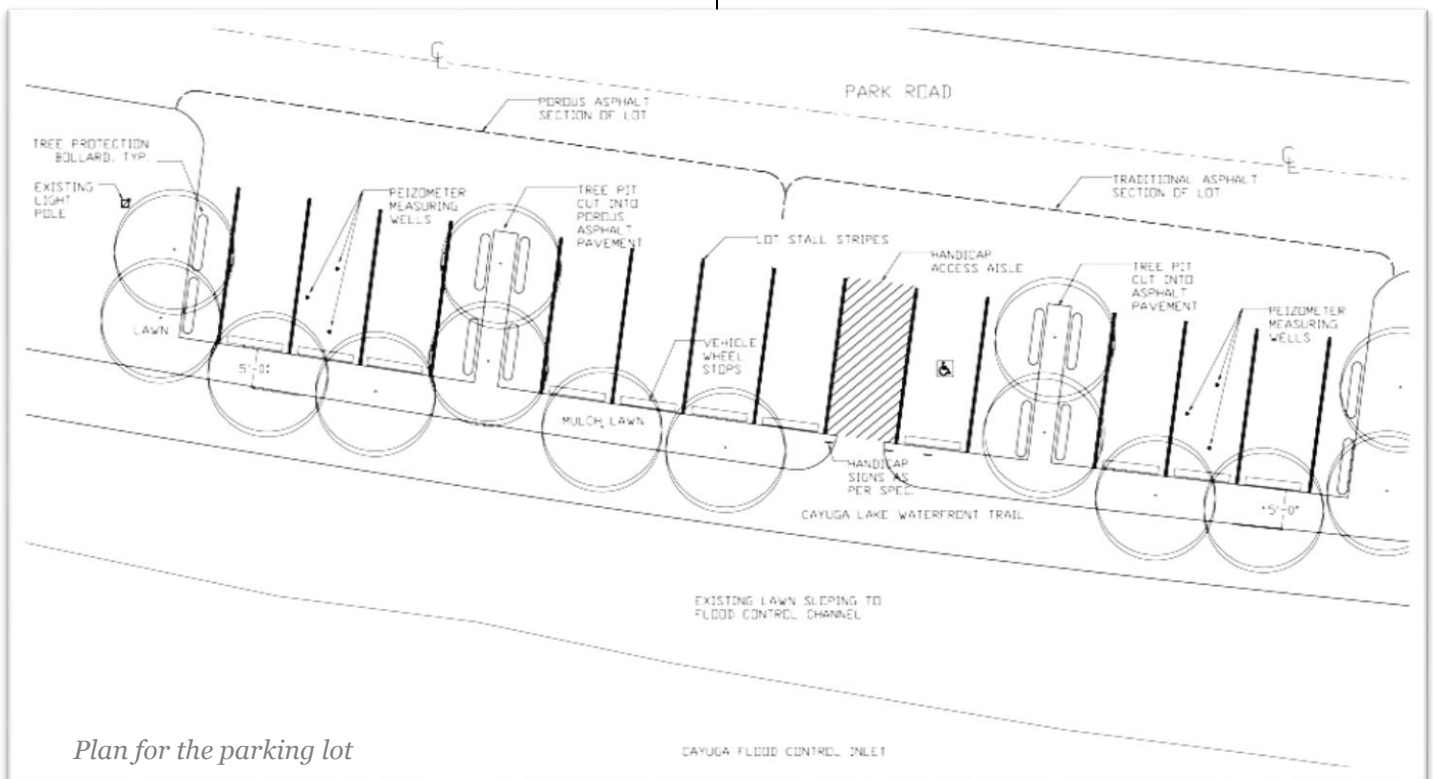

Plan for the parking lot



CU Structural Soil® was used as a 2' deep base course for the entire parking lot



Planting the bare root elms directly into CU-Soil® in 2005

In the middle of each pavement profile type (porous or impervious asphalt), 3' wide tree pits were cut, running the entire 18' width of the lot to the shoulder of the adjacent roadway. Within each tree pit, two bare root 1.5" caliper Accolade Elms (*Ulmus japonica* x *Ulmus wilsoniana* 'Accolade') were installed. Eight other Accolade Elms of the same size were planted within a 2' adjacency surrounding the parking lot with four of these adjacent to the porous asphalt profile and four of these adjacent to the traditional asphalt profile



The finished parking lot



The saw-cut planting bed with holes dug in the CU-Soil® for tree planting.



Spring 2006



Growth as of 2009



Growth as of 2014

McCarren Park, Brooklyn NY

In 1997, a streetscape project adjacent to McCarren Park in Brooklyn, NY, included CU-Structural Soil® in the design. On one side of the street, CU-Soil® was used as a 24” base course for the entire length and width of the sidewalk, with regularly spaced tree pits that included removable permeable stone pavers.

The trees planted on the other side of the street were placed in a standard tree lawn, allowing for easy growth comparisons to be made over the years.

After 17 years of observation the trees growing in CU-Soil® are comparable to those growing in the tree lawn across the street. Ground penetrating radar data suggests that the tree roots have thoroughly colonized the CU-Soil® profile.



Growth after 3 years



One of the trees planted in the tree lawn. The trees visible across the street are planted in a continuous trench of CU-Structural Soil®



Growth after 9 years. Photo courtesy Amereq, Inc.



Streetscape after 10 years. Photo courtesy Amereq, Inc.



Streetscape after 15 years. Photo courtesy Amereq, Inc.



Growth after 14 years. Photo courtesy Amereq, Inc.



Streetscape after 17 years. Photo courtesy Amereq, Inc.

W. State Street, Ithaca NY



Extents of the W. State Street project

A 1999 project to retrofit many blocks of W. State Street in Ithaca, NY provided an opportunity to create block-long continuous trenches of CU-Structural Soil® in the newly constructed streetscape. There were a number of mature trees growing in existing tree pits that were kept during the project. CU-Soil® was constructed right up to the existing tree pits on either side. This effectively freed the roots of the mature tree from the cramped tree pit, and allowed them to explore the lengthy trenches of CU-Soil®. New tree pits were also created.

In this project, in many areas, the species used for the new tree plantings were chosen in order to maintain visual similarity with the existing trees.



*Installation of the new sidewalk on a base of CU-Soil®.
This picture also shows an existing mature tree*



Growth after 10 years. The two trees on the right are mature Zelkovas that were preserved during the retrofitting. The two new trees on the left are Homestead elms that were planted following the retrofitting.



A typical tree pit on W. State Street. The colored concrete sections correspond with the extents of the CU-Soil® volume.

Green Street, Ithaca NY



Location of the project. The green line represents a continuous trench of CU-Soil®

A project in 2003 involved redoing a streetscape in downtown Ithaca, NY. The site, Green Street, is one of the most urban sites in Ithaca. It sees high volumes of vehicular traffic and serves as a major bus station, meaning that the street trees here are constantly exposed to exhaust from idling buses. The design uses an 8' wide by 24" deep trench of CU-Soil® that provides a continuous soil volume that is shared among all of the trees.

The trees planted here are an interesting aspect of the project. These trees are Chinkapin Oak (*Quercus muehlenbergii*), a tall-growing species that is rarely used as a street tree, but is notable because of its incredible tolerance to highly alkaline soils. The growth and health of these trees attest to this species' ability to withstand difficult urban stresses.



Green Street is one of the busiest streets in Ithaca, and the site of a bus station. The trees are constantly exposed to the exhaust from idling buses.



A continuous trench of CU-Soil® connects each tree pit to one another



Aerial view in 2014, eleven years after planting.



Growth as of 2006, three years after planting.



Growth as of 2014, eleven years after planting.

Mann Library, Ithaca NY

An academic building renovation and a plan for a newly paved plaza space threatened a mature Katsura Tree (*Cercidiphyllum japonicum*) on the Cornell University campus. The standard method for installing a new paved area, which involves excavating down into the soil 18" or more, would have destroyed much of the tree's root system and led to its demise.

Working with the designers during the initial stages of design, it was found that CU-Soil® could play a role in saving the tree. Rather than using the standard methods, the paved plaza space was built on top of the existing tree root-system, which experienced very little damage during construction. In 2014, soil was first cleared from the tree roots using a minimally invasive air excavation tool. On top of the newly exposed roots, CU-Soil® was placed and compacted to form the base course for the plaza. On top of this, pavers with an open, porous joint were installed. This project provides a unique example of how CU-Soil® can be utilized to save mature trees when new paving threatens their root systems.



Soil around the roots was excavated using an air excavation tool



12"-15" of CU-Soil® was placed on top of the exposed roots and compacted for use as a base course for the paving



Permeable pavers were installed over the CU-Soil® and mature tree roots



Void space between individual pavers allows water and air to infiltrate



The nearly finished plaza space

Car Dealership Turf Median, Birmingham, AL

Turf on CU-Structural Soil® has been successfully used at a car dealership in Birmingham, AL. At this installation, the soil in an entire median was excavated and replaced with CU-Structural Soil® and sod was placed on top. After installation, the entire median can properly withstand the compaction from the weight of the cars and serves as a flexible open space for the dealership, providing additional space to display inventory, or as overflow parking.



Installation and compaction of the CU- Soil®. Photo courtesy Southpine, Inc.



The finished installation. Photo courtesy Southpine, Inc.



The turf median is used as a parking and display space. Photo courtesy Holcombe Norton Partners



The turf median in winter. Photo courtesy Southpine, Inc.

PART IV

Resources

Installation Specifications

1.1 GENERAL

- A. The work of this section consists of all structural soil work and related items as indicated on the drawings or as specified herein and includes, but is not limited to, the following:

CU-Soil® is a proprietary material patented by Cornell University and marketed under the registered trademark, CU-Structural Soil®. Only licensed companies are authorized to produce this material, meeting the specifications described in this text. For a list of licensed CU-Soil® producers, call AMEREQ, INC. at 800-832-8788.

1.2 DELIVERY, STORAGE AND HANDLING

- A. Delivered CU-Structural Soil® shall be at or near optimum compaction moisture content as determined by AASHTO T 99 (ASTM D 698) and should not be placed in frozen, wet or muddy sites.
- B. Protect CU-Structural Soil® from exposure to excess water and from erosion at all times. Do not store CU-Soil® unprotected. Do not allow excess water to enter site prior to compaction. If water is introduced into the CU-Soil® after grading, allow water to drain to optimum compaction moisture content.

1.3 EXAMINATION OF CONDITIONS

- A. All areas to receive CU-Structural Soil® shall be inspected by the installing contractor before starting work and all defects such as incorrect grading, compaction, and inadequate drainage shall be reported to the engineer prior to beginning this work.

1.4 QUALITY ASSURANCE

- A. Qualifications of installing contractor: The work of this section should be performed by a contracting firm which has a minimum of five years experience. Proof of this experience shall be submitted as per paragraph, SAMPLES and SUBMITTALS, of this section.

1.5 UNDERGROUND UTILITIES AND SUBSURFACE CONDITIONS

- A. The installing contractor shall notify the engineer of any subsurface conditions which will affect the contractor's ability to install the CU-Soil®.
- B. The installing contractor shall locate and confirm the location of all underground utility lines and structures prior to the start of any excavation.
- C. The installing contractor shall repair any underground utilities or foundations damaged during the

progress of this work.

1.6 SITE PREPARATION

- A. Do not proceed with the installation of the CU-Structural Soil[®] material until all walls, curb footings and utility work in the area have been installed. For site elements dependent on CU-Structural Soil[®] for foundation support, postpone installation of such elements until immediately after the installation of CU-Structural Soil[®].
- B. Install subsurface drain lines as shown on the plan drawings prior to installation of CU-Structural Soil[®] material.
- C. Excavate and compact the proposed subgrade to depths, slopes and widths as shown on the drawings. Maintain all required angles of repose of the adjacent materials as shown on the drawings. Do not over excavate compacted subgrades of adjacent pavement or structures.
- D. Confirm that the subgrade is at the proper elevation and compacted as required. Subgrade elevations shall slope parallel to the finished grade and/or toward the subsurface drain lines as shown on the drawings.
- E. Clear the excavation of all construction debris, trash, rubble and any foreign material. In the event that fuels, oils, concrete washout silts or other material harmful to plants have been spilled into the subgrade material, excavate the soil sufficiently to remove the harmful material. Fill any over excavation with approved fill and compact to the required subgrade compaction.
- F. Do not proceed with the installation of CU-Structural Soil[®] until all utility work in the area has been installed. All subsurface drainage systems shall be operational prior to installation of CU-Structural Soil[®].
- G. Protect adjacent walls, walks and utilities from damage. Use ½" plywood and/or plastic sheeting as directed to cover existing concrete, metal and masonry work and other items as directed during the progress of the work.
 - 1. Clean up all trash and any soil or dirt spilled on any paved surface at the end of each working day.
 - 2. Any damage to the paving or architectural work caused by the installing contractor shall be repaired, as directed by the engineer.
- H. Maintain all silt and sediment control devices required by applicable regulations. Provide adequate methods to assure that trucks and other equipment do not track soil from the site onto adjacent property and the public right of way.

1.7 WATER

- A. The installing contractor shall be responsible to furnish his own supply of water (if needed) free of impurities, to the site.

1.8 INSTALLATION OF CU-STRUCTURAL SOIL® MATERIAL

- A. Install CU-Structural Soil® in 6 inch lifts and compact each lift.
- B. Compact all materials to at least 95% Proctor Density from a standard compaction curve AASHTO T 99 (ASTM D 698). No compaction shall occur when moisture content exceeds maximum as listed herein. Delay compaction if moisture content exceeds maximum allowable and protect CU-Structural Soil® during delays in compaction with plastic or plywood as directed by the engineer.
- C. Bring CU-Structural Soil® to finished grades as shown on the drawings. Immediately protect the CU-Structural Soil® from contamination by toxic materials, trash, debris, water containing cement, clay, silt or materials that will alter the particle size distribution of the mix with plastic or plywood as directed by the engineer.
- D. The engineer may periodically check the material being delivered, prior to installation for color and texture consistency with the approved sample provided by the installing contractor as part of the submittal for CU-Structural Soil®. If the engineer determines that the delivered CU-Soil® varies significantly from the approved samples, the engineer shall contact the licensed producer.
- E. Engineer shall ensure that the delivered structural soil was produced by the approved CU-Soil® licensee by inspecting weight tickets showing source of material.
- F. CU-Soil® should not be stockpiled long-term. Any CU-Soil® not installed immediately should be protected by a tarp or other waterproof covering.

1.9 FINE GRADING

- A. After the initial placement and rough grading of the CU-Structural Soil® but prior to the start of fine grading, the installing contractor shall request review of the rough grading by the engineer. The installing contractor shall set sufficient grade stakes for checking the finished grades.
- B. Adjust the finish grades to meet field conditions as directed.
Provide smooth transitions between slopes of different gradients and direction.
Fill all dips with CU-Soil® and remove any bumps in the overall plane of the slope.
 - a. The tolerance for dips and bumps in CU-Structural Soil® areas shall be a 3” deviation from the plane in 10’.All fine grading shall be inspected and approved by the engineer prior to the installation of other items to be placed on the CU-Structural Soil®.
- C. The engineer will inspect the work upon the request of the installing contractor. Request for inspection shall be received by the engineer at least 10 days before the anticipated date of inspection.

1.10 ACCEPTANCE STANDARDS

- A. The engineer will inspect the work upon the request of the installing contractor. Request for inspection shall be received by the engineer at least 10 days before the anticipated date of inspection.

1.11 CLEAN-UP

- A. Upon completion of the CU-Structural Soil[®] installation operations, clean areas within the contract limits. Remove all excess fills, soils and mix stockpiles and legally dispose of all waste materials, trash and debris. Remove all tools and equipment and provide a clean, clear site. Sweep, do not wash, all paving and other exposed surfaces of dirt and mud until the paving has been installed over the CU-Structural Soil[®] material. Do no washing until finished materials covering CU-Structural Soil[®] material are in place.

© 2008-2009, 2012, 2014

END OF SECTION

Choosing Trees Appropriate for use in CU-Structural Soil®

As in any street tree planting, it is important to choose species that can withstand the conditions they will encounter in an urban setting. Drought tolerant tree species are recommended for planting in CU-Structural Soil®, which has an available water holding capacity of between 7-12%. The crushed stone component of the CU-Soil® whether limestone, granite, or other aggregate, will ultimately influence soil pH, and this has to be taken into consideration when selecting tree species. CU-Structural Soil® made with limestone generally ends up with a soil pH of about 8.0, regardless of the soil pH when the material was first mixed. For many parts of the country, this is not unusually high, and is especially common in urban areas. Using aggregates that do not influence pH, such as granite, may not affect pH as quickly, but the soil pH value will continue to increase as adjacent concrete slowly breaks down. A CU-Structural Soil® system provides an opportunity for choosing alkaline-tolerant species that require good drainage and are somewhat drought tolerant. As with any planting, local climate will greatly affect what tree species are suitable.

As an example, the following list of trees are both alkaline and drought tolerant. These species are suitable for Ithaca, New York, and other similar temperate climates. This list is just to provide a sampling. These species are certainly not the only species that are suitable for growing in a CU-Structural Soil® system. New trees in CU-Soil® must be watered for the first several years until they become established on the site. Lindens (*Tilia* spp.) in particular may need supplemental water in the first three years.

Botanic Name	Common Name
<i>Acer campestre</i>	Hedge Maple
<i>Acer miyabei</i>	Miyabe Maple
<i>Acer truncatum</i>	Painted Maple
<i>Celtis occidentalis</i>	Hackberry
<i>Cercis canadensis</i>	Redbud
<i>Crataegus crus-galli</i>	Cockspur Hawthorn
<i>Crataegus phaenopyrum</i>	Washington Hawthorn
<i>Crataegus viridis</i>	Green Hawthorn
<i>Eucommia ulmoides</i>	Hardy Rubber Tree
<i>Ginkgo biloba</i>	Ginkgo
<i>Gleditsia triacanthos</i>	Honey Locust
<i>Gymnocladus dioicus</i>	Kentucky Coffee Tree
<i>Koelreuteria paniculata</i>	Goldenrain tree
<i>Maclura pomifera</i>	Osage Orange
<i>Malus</i> spp.	Crabapple

Botanic Name	Common Name
<i>Platanus x acerifolia</i>	London Plane
<i>Pyrus calleryana</i>	Callery Pear
<i>Quercus macrocarpa</i>	Mossy Cup Oak
<i>Quercus muehlenbergii</i>	Chinkapin Oak
<i>Quercus robur</i>	English Oak
<i>Robinia pseudacacia</i>	Black Locust
<i>Styphnolobium japonicum</i>	Japanese Pagoda Tree
<i>Syringa reticulata</i>	Japanese Tree Lilac
<i>Tilia cordata</i>	Littleleaf Linden
<i>Tilia tomentosa</i>	Silver Linden
<i>Tilia x euchlora</i>	Crimean Linden
<i>Ulmus parvifolia</i>	Lace Bark Elm
<i>Ulmus</i> spp.	Elm Hybrids
<i>Zelkova serrata</i>	Japanese Zelkova

Standard Design Details

CU-Structural Soil® Break-out Zone from Narrow Tree Lawn to Adjacent Property

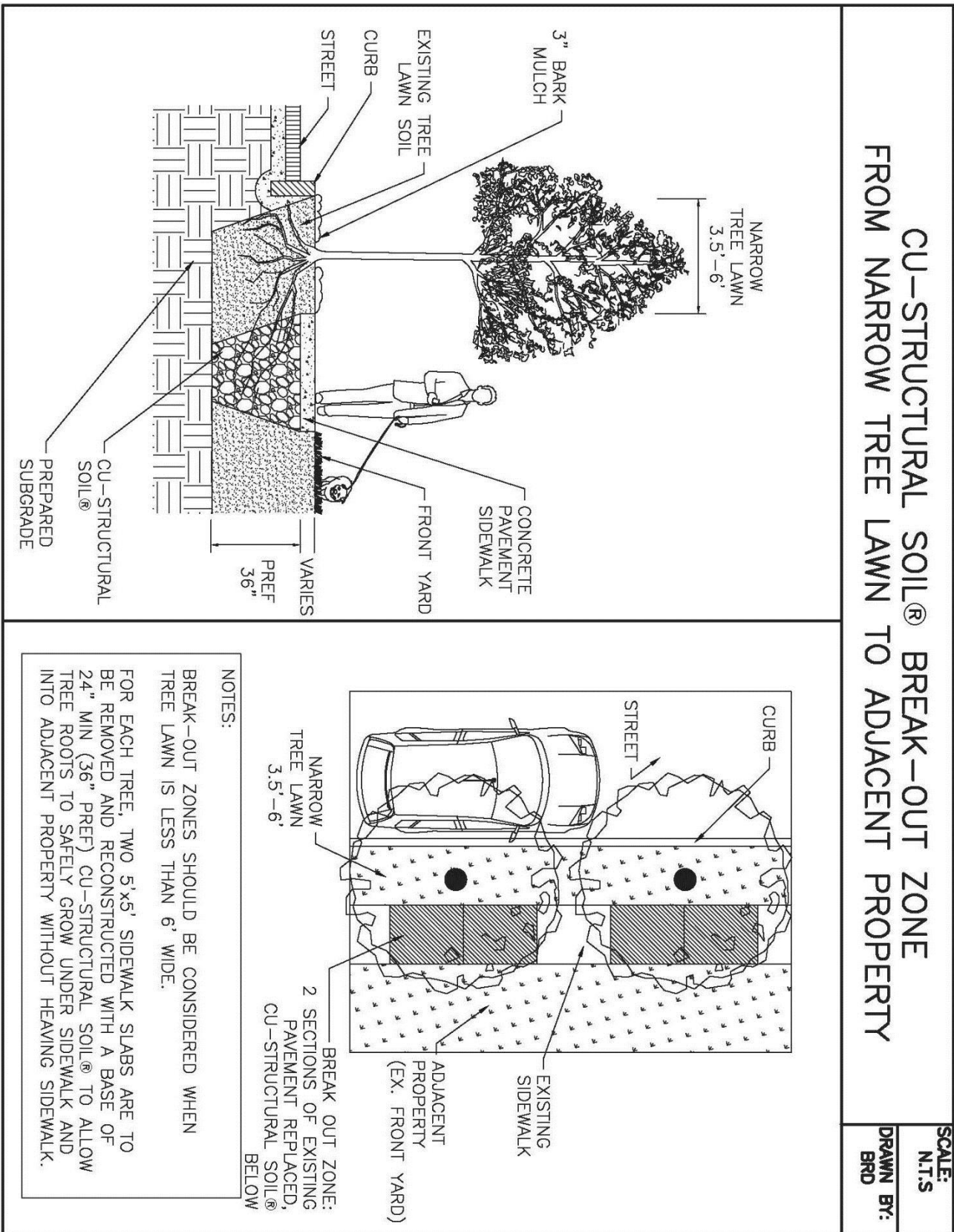

**CU-STRUCTURAL SOIL® BREAK-OUT ZONE
FROM NARROW TREE LAWN TO ADJACENT PROPERTY**

SCALE:
N.T.S.
DRAWN BY:
BRD

NOTES:

BREAK-OUT ZONES SHOULD BE CONSIDERED WHEN TREE LAWN IS LESS THAN 6' WIDE.

FOR EACH TREE, TWO 5'x5' SIDEWALK SLABS ARE TO BE REMOVED AND RECONSTRUCTED WITH A BASE OF 24" MIN (36" PREF) CU-STRUCTURAL SOIL® TO ALLOW TREE ROOTS TO SAFELY GROW UNDER SIDEWALK AND INTO ADJACENT PROPERTY WITHOUT HEAVING SIDEWALK.

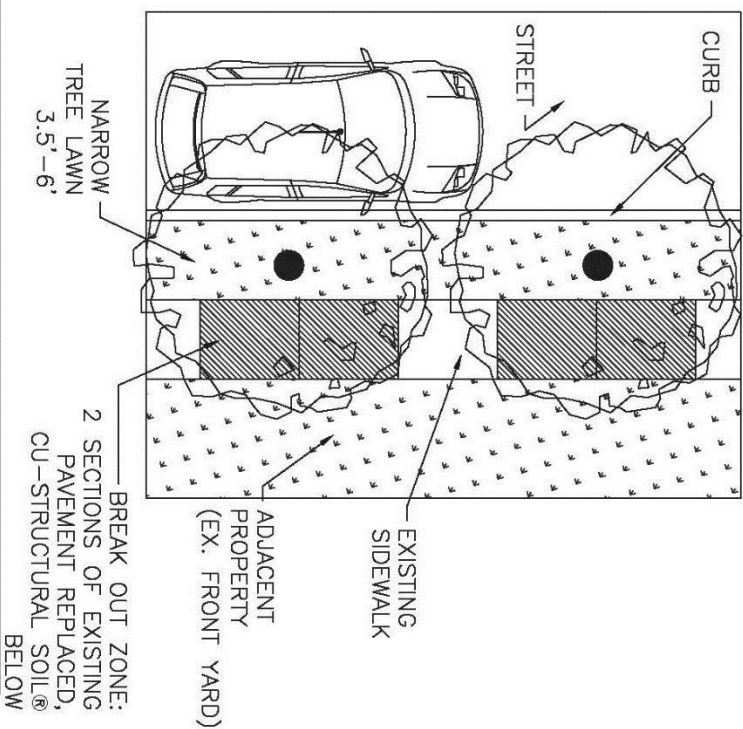

Typical Tree Planting Pit with CU-Structural Soil® along Sidewalk

**TYPICAL TREE PLANTING PIT
WITH CU-STRUCTURAL SOIL® ALONG SIDEWALK**

SCALE:
N.T.S.
DRAWN BY:
BRD

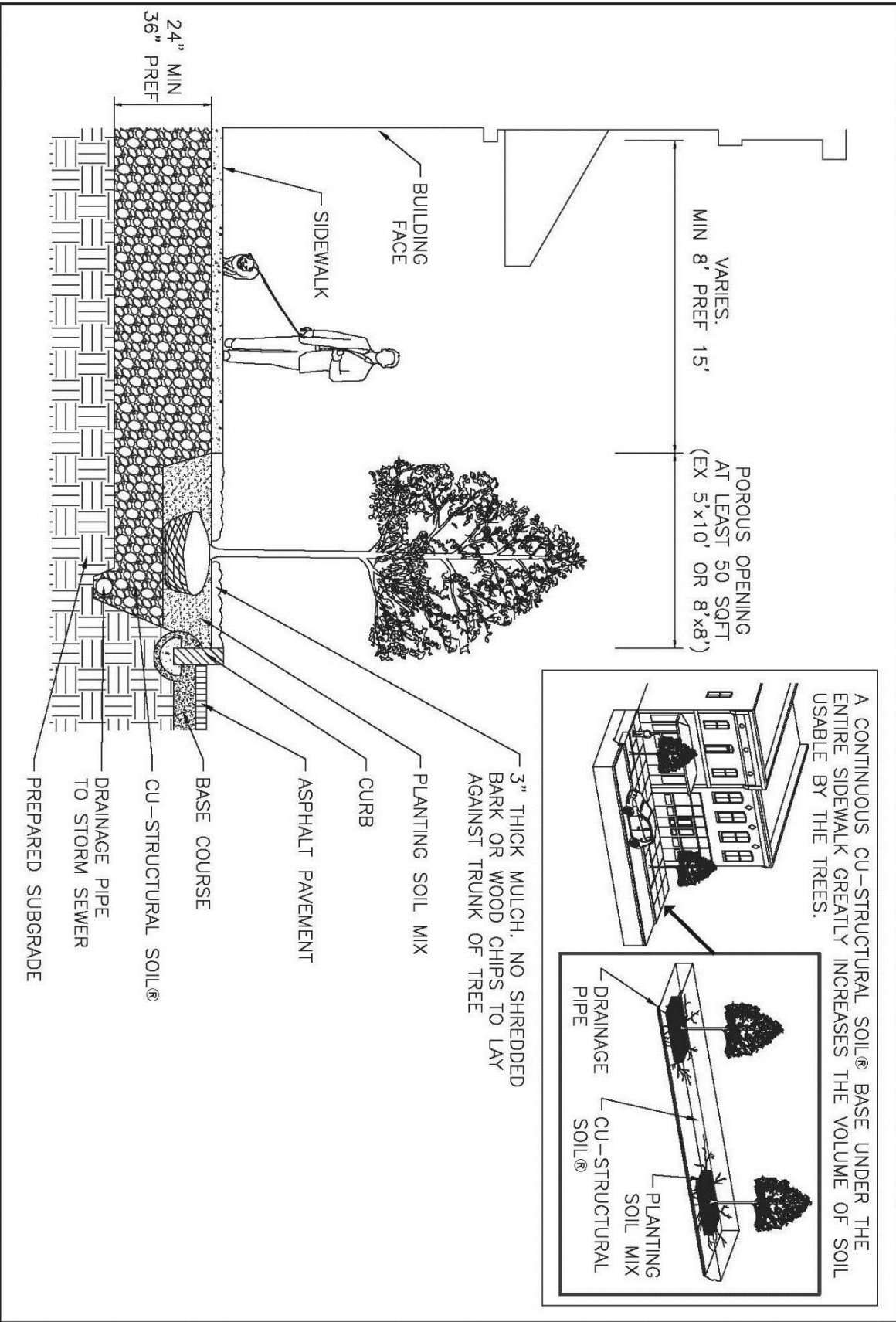

Typical Tree Planting Island in a Parking Lot with CU-Structural Soil®

TYPICAL TREE PLANTING ISLAND IN A PARKING LOT WITH CU-STRUCTURAL SOIL®

SCALE: N.T.S.
DRAWN BY: BRD

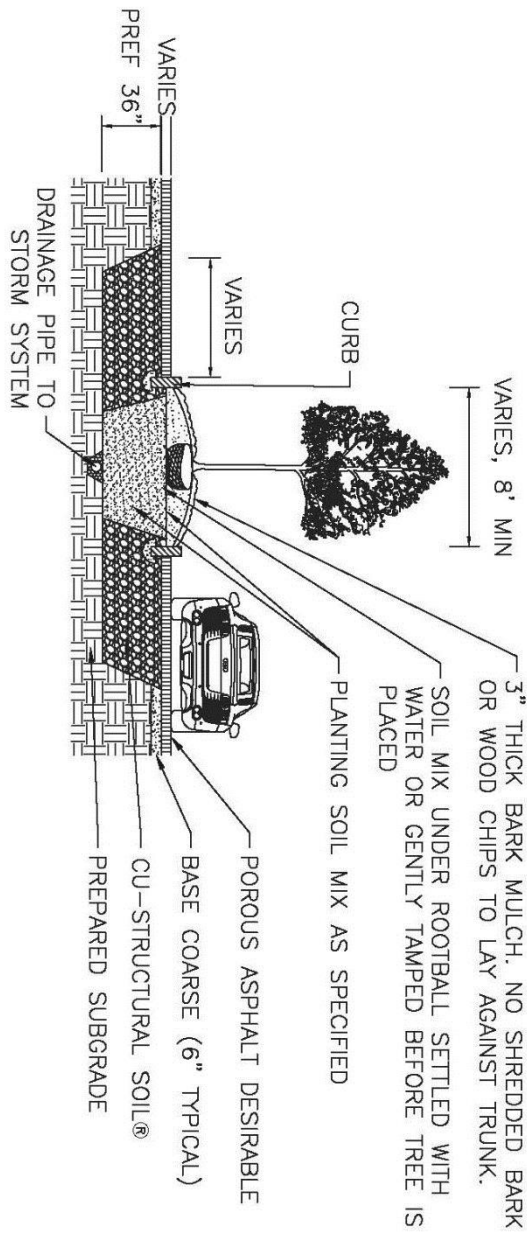

A TYPICAL 36' x 8' PARKING LOT ISLAND WITH 3' DEPTH OF SANDY LOAM SOIL CAN SUPPORT:

- WITH NO CU-STRUCTURAL SOIL®
 - 2 SMALL TREES (<30' TALL AT MATURITY)
 - WITH 150 CU FT CU-STRUCTURAL SOIL® (EX. 36' x 4.25' x 3')
 - 1 LARGE TREE (30'-50' TALL AT MATURITY)
 - WITH 1215 CU FT CU-STRUCTURAL SOIL® (EX. 36' x 12' x 3')
 - 1 VERY LARGE TREE (>50' TALL AT MATURITY)

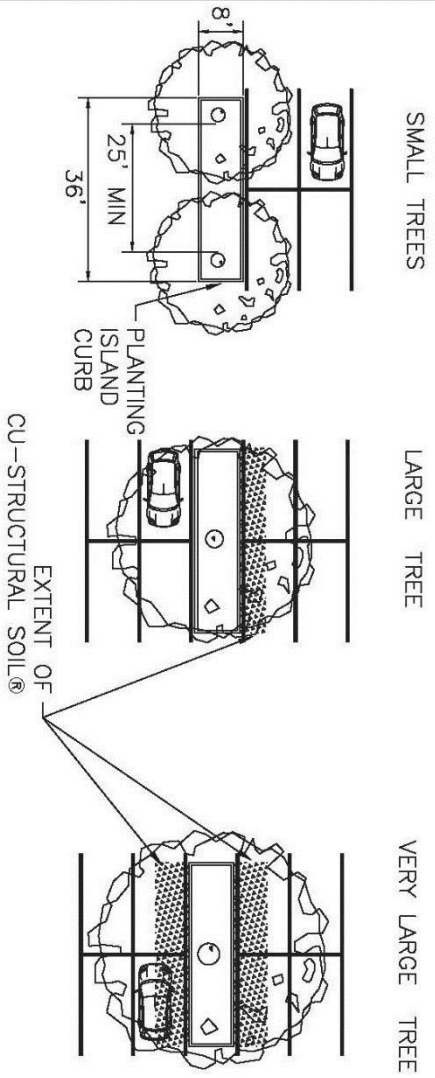

Further Information

- Bassuk, Nina, Peter Trowbridge, and Jason Grabosky. "Structural Soil -- Part 1." *The Field*. ASLA, 30 Jan. 2014. Web. 15 Dec. 2014.
- Bassuk, Nina, Peter Trowbridge, and Jason Grabosky. "Structural Soil -- Part 2." *The Field*. ASLA, 19 Feb. 2014. Web. 15 Dec. 2014.
- Beard, James B. "Turfgrass: Science and Culture" Prentice-Hall, Inc. Englewood Cliffs, N.J. 1973
- Cahill, Thomas, Adams, Michelle, and Marm, Courtney. *Porous Asphalt: The Right Choice for Porous Pavements*, Hot Mix Asphalt Technology September-October.
- Cahill, Thomas. A second Look at Porous Pavement/Underground Recharge, *Watershed Protection Techniques* 1, 76-78.
- Cahill, Thomas. *Porous Pavement with Underground Recharge Beds*, Engineering Design Manual, West Chester PA: Cahill Design Associates 1993
- Evans, M., Bassuk, N.L. and Trowbridge, P.J. 1990. Street trees and sidewalk construction. *Landscape Architecture*. 80(3) 102-103.
- Ferguson, Bruce K. "Porous Pavements" Taylor and Francis Group; Boca Raton, London, New York, Singapore, 2005
- Ferguson, Bruce K. "Preventing the Problems of Urban Runoff" *Renewable Resources Journal* (Winter 1995-1996) 14-18
- Goldstein, J., Bassuk, N.L., Lindsey, P., and Urban, J. 1991. From the Ground Down. *Landscape Architecture*, 81(1) 66-68.
- Grabosky J. and Bassuk N.L. 1995. A New Urban Tree Soil to Safely Increase Rooting Volumes Under Sidewalks. *Journal of Arboriculture*, 21(4) 187-201.
- Grabosky, J and Bassuk N.L 2008 Sixth- and Tenth-Year Growth Measurements for Three Tree Species in a Load-Bearing Stone-Soil Blend Under Pavement and a Tree Lawn in Brooklyn, New York, U.S. *J. of Arboriculture and Urban Forestry*34 (4):265-266
- Grabosky, J, Haffner, E and Bassuk,N.L. 2009. Plant Available Moisture in Stone-soil Media for use Under Pavement While Allowing Urban Tree Root Growth. *Arboriculture & Urban Forestry* 35(5): 271-278
- Grabosky, J., Bassuk, N., Trowbridge, P. 2000 "Structural Soil: A New Medium to Allow Trees to Grow in Pavement" *Landscape Architecture Technical Information Series Online (LATIS)* <http://www.asla.org> 37pages.
- Grabosky, J., Bassuk, N.L. and Van Es, H. 1996. Testing of Structural Urban Tree Soil Materials for Use Under Pavement to Increase Street Tree Rooting Volumes. *Journal of Arboriculture*, Vol. 22 No. 6, 255-263.
- Grabosky, J., Bassuk, N.L., and Marranca, M.B. 2002. Preliminary Findings from Measuring Street Tree Shoot growth in two Skeletal Soil Installations Compared to Tree Lawn Plantings. *Journal of Arboriculture* 28(2):106-108.
- Grabosky, J., Bassuk, N.L., Irwin, L. and Van Es, H. 2001. Shoot and Root Growth of Three Tree Species in Sidewalks. *J. Environmental Hort.* 19(4):206-211.
- Grabosky, J., Bassuk, N.L., Irwin, L., and Van Es, H. 1999. A Pilot Field Study of Structural Soil Materials in Pavement. *The Landscape Below Ground II: Proceedings of an International Workshop on Tree Root Development in Urban Soils*. San Francisco, CA: International Society of Arboriculture, 210-221.
- Grabosky, J., Bassuk, N.L., Irwin, L., and Van Es, H. 1999. Structural Soil Investigations at Cornell University. *The Landscape Below Ground II: Proceedings of an International Workshop on Tree Root Development in Urban Soils*. San Francisco, CA: International Society of Arboriculture, 203-209.

- Grabosky, J., Bassuk, N.L., Urban, J. and Trowbridge, P. 1998. Structural Soil: An Innovative Medium Under Pavement that Improves Street Tree Vigor. ASLA Proceedings Annual Conference, pp183-185.
- Grabosky, J., Bassuk, N. and Marranca, M. 2002 "Preliminary Findings from Measuring Street Tree Shoot growth in two Skeletal Soil Installations Compared to Tree Lawn Plantings" *Journal of Arboriculture* 28(2) 106-108.
- Lindsey, P. and Bassuk, N. 1991. Specifying Soil Volumes to Meet the Water Needs of Mature Urban Street Trees and Trees in Containers. *Journal of Arboriculture*. 17(6) 141-149.
- Lindsey, P. and Bassuk, N.L. 1992. Redesigning the Urban Forest from the Ground Below: A New Approach to Specifying Adequate Soil Volumes for Street Trees. *Arboricultural Journal*. 16(1) 25-39.
- Loh, F.C.W., Grabosky, J.C., and Bassuk, N.L. 2003. Growth Response of *Ficus benjamina* to Limited Soil Volume and Soil Dilution in a Skeletal Soil Container Study. *Urban Forestry & Urban Greening*. 2(1):53-62.
- National Asphalt Pavement Association, 2004. Porous Asphalt Pavement Seminars, Lanham, Maryland.
- New York State Department of Environmental Conservation. TOGS 5.1.10: "General Permit for Construction Activities, Appendix D: <http://www.dec.state.ny.us/website/dow/appndixd.htm>
- Thelen, Edmund, Grover, Wilford C., Hoiberg, Arnold J., Haigh, Thomas, I. "Investigation of Porous Pavements for Urban Runoff Control" Environmental Protection Agency, 1972.
- Trowbridge, P. and Bassuk, N.L. 1999. Redesigning Paving Profiles for a More Viable Urban Forest. ASLA Proceedings Annual Conference, pp. 350-351. 13(2): 64-71.
- Trowbridge, P. and Bassuk, N.L. 2004. 'Trees in the Urban Landscape: Site Assessment, Design and Installation'. Chapter 3:61-81. Wiley and Sons, Inc.
- Turgeon, A.J. 2005. 'Turfgrass Management, 7th Edition' Pearson Education, Inc. Upper Saddle River, N.J.